

SIRIUS HRI brand

High-pressure discharge lamps with reflector



Áreas de aplicação

- Architecture & Architainment

Benefícios do produto

- Lightweight and compact reflector lamps
- Perfectly suited for small and lightweight moving heads
- Design do queimador otimizado permite posição de funcionamento universal
- High luminance through very short arc and high pressure
- Luz brilhante para efeitos de luz brilhantes
- Vida útil longa
- Easy lamp replacement
- Stable light output over the entire lifetime



Ficha técnica da família de produto

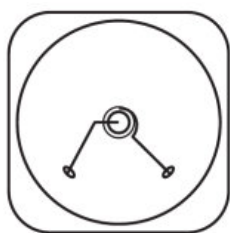
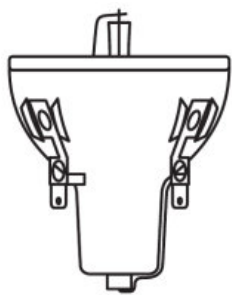

666507_SIRIUS HRI 100W

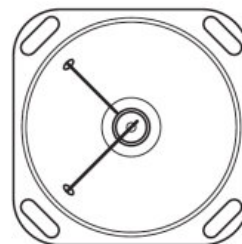
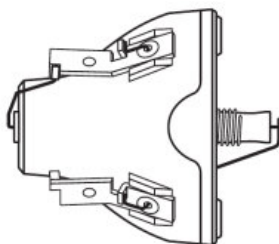

350611_SIRIUS HRI 132W

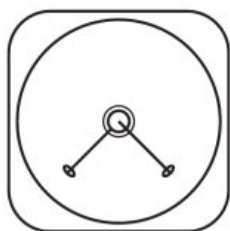
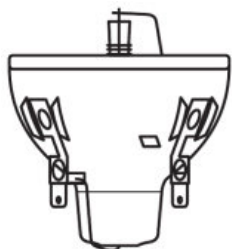

488735_SIRIUS HRI 132W

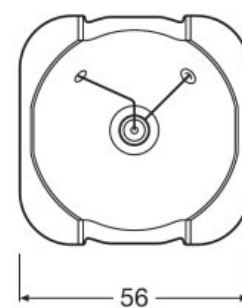
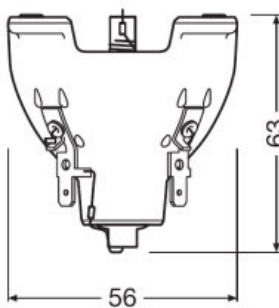

501950_SIRIUS HRI 330W

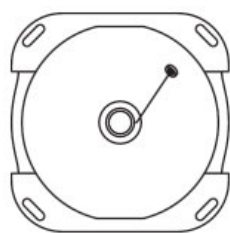
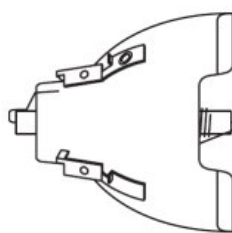

333382_SIRIUS HRI 330W

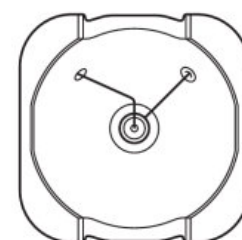
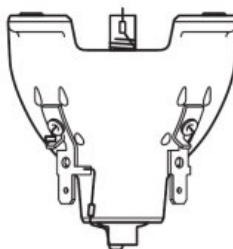

501965_SIRIUS HRI 330W

Ficha técnica da família de produto

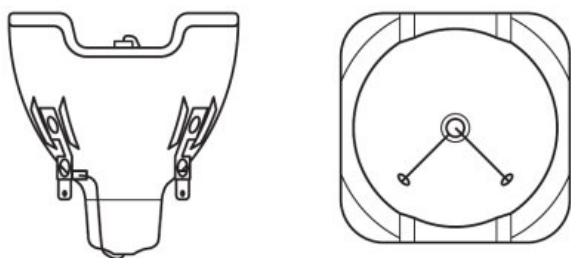

488771_SIRIUS HRI 330W X8

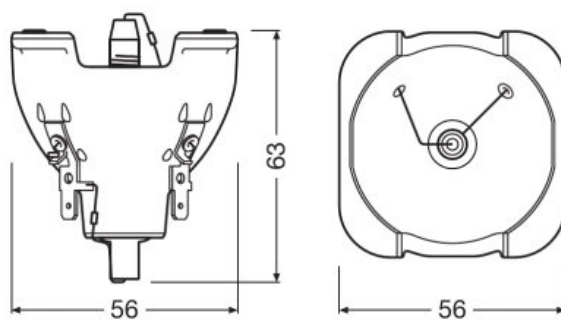

501949_Sirius HRI 330W XL

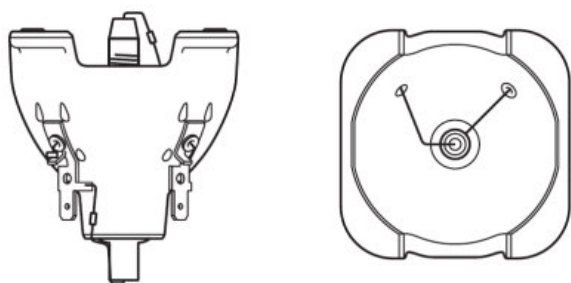

501963_Sirius HRI 330W XL

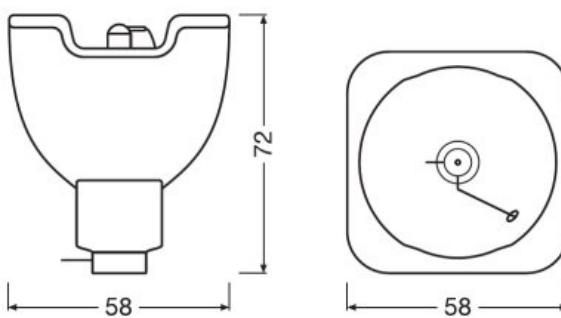

SIRIUS HRI 371W

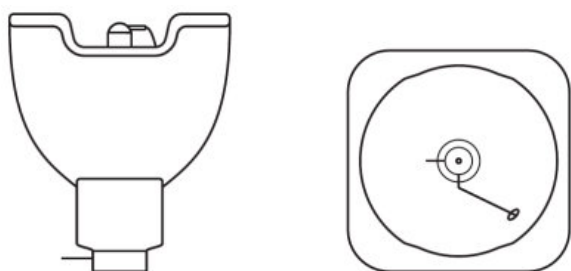

SIRIUS HRI 371W

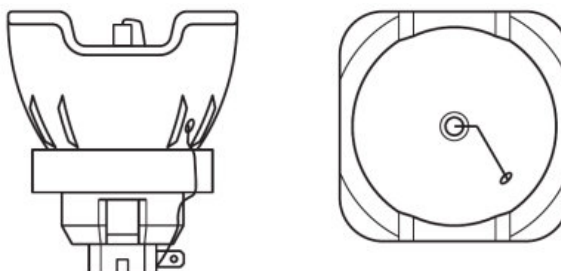

668858_SIRIUS HRI 440W

Ficha técnica da família de produto

Dados técnicos

Descrição do produto	Dados Elétricos		Dados fotométricos				Dados Luminotécnicos
	Potência nominal	Corrente nominal	Fluxo luminoso nominal	Temperatura de cor	Índice de reprodução de cor Ra	Máxima temperatura de cor	Comprimento do foco
SIRIUS HRI 100 W	100,00 W	1,8 A	3680 lm	9000 K	60	9300 K	30.0 mm
SIRIUS HRI 132 W SC	132,00 W	1,8 A	5150 lm	9200 K	60	9200 K	37.7 mm
SIRIUS HRI 140 W RO	140,00 W	1,9 A	5400 lm	9200 K	60	9200 K	37.7 mm
SIRIUS HRI 190 W+	190,00 W	2,2 A	8100 lm	8200 K	73	8200 K	34,5 mm
SIRIUS HRI 230 W	230,00 W	3,3 A	9500 lm	8000 K	75	8000 K	34,5 mm
SIRIUS HRI 231 W	231,00 W	3,3 A	10800 lm	8000 K	75		
SIRIUS HRI 251 W	250,00 W	3,5 A	12000 lm	8000 K	77		
SIRIUS HRI 260 W PRO	260,00 W	3,7 A	13500 lm	7800 K	79		
SIRIUS HRI 280 W	280,00 W	4 A	11500 lm	7800 K	78	7800 K	35.5 mm
SIRIUS HRI 280 W RO	280,00 W	4 A	11500 lm	7800 K	78		
SIRIUS HRI 281 W	281,00 W	4 A	13000 lm	7800 K	78		
SIRIUS HRI 310 W PRO	310,00 W	5 A	15500 lm	7650 K	85		
SIRIUS HRI 311 W	310,00 W	3,3 A	14500 lm	8000 K	75		
SIRIUS HRI 330 W	330,00 W	5 A	18000 lm	7400 K	86	7400 K	31.0 mm
SIRIUS HRI 330 W X8	330,00 W	4,4 A	18000 lm	8000 K	85		
SIRIUS HRI 330 W XL	330,00 W	5 A	16500 lm	7250 K	71		
SIRIUS HRI 370W LL	370,00 W	5 A	18000 lm	7400 K	86		
SIRIUS HRI 371 W	371,00 W	5 A	18300 lm	7650 K	85		
SIRIUS HRI 371 W S	371,00 W	5 A	19800 lm	7650 K	85		
SIRIUS HRI 371 W +	370,00 W	5 A	18300 lm	7650 K	85		
HRI 371 W S +	370,00 W	5 A	19800 lm	7650 K	85		
SIRIUS HRI 380 W Pro	380,00 W	5 A	20000 lm	7700 K	85		
SIRIUS HRI 420 W	420,00 W	5 A	22000 lm	7700 K	85		
SIRIUS HRI 440 W	440,00 W	5,3 A	20000 lm	7000 K	80	7000 K	41.0 mm
SIRIUS HRI 440 W H	440,00 W	5,3 A	18000 lm	7000 K	75		
SIRIUS HRI 440 W S	440,00 W	4,4 A	22800 lm	7000 K	80		
SIRIUS HRI 440 W X	440,00 W	5,3 A	22800 lm	7000 K	80		
SIRIUS HRI 461 W	461,00 W	5,3 A	24000 lm	7500 K	80		
SIRIUS HRI 461 W S	461,00 W	5,3 A	24000 lm	7500 K	80		
SIRIUS HRI 470 W S	470,00 W	5,3 A	21500 lm	7000 K	80		
SIRIUS HRI 470 W RO	470,00 W	5,3 A	19500 lm	7500 K	80		
SIRIUS HRI 470 W XL	470,00 W	5,3 A	24000 lm	7500 K	80		
SIRIUS HRI 471 W SN	471,00 W	5,3 A	20000 lm	7500 K	80		
SIRIUS HRI 550 W	550,00 W	6,1 A	28000 lm	7000 K	75		

Ficha técnica da família de produto

Descrição do produto	Abertura da janela (máxima)	Dimensões e peso		Espectativa de Vida	Atributos	
		Diâmetro	Comprimento		Posição de funcionamento	Resfriamento
SIRIUS HRI 100 W	5x3.8 mm	45,0 mm	53,0 mm	6000 h	Qualquer	Arrefecimento forçado
SIRIUS HRI 132 W SC	5x3.8 mm	46,0 mm	max. 44 mm	6000 h	Qualquer	Arrefecimento forçado
SIRIUS HRI 140 W RO	5x3.8 mm	46,0 mm	max. 44 mm	6000 h	Qualquer	Arrefecimento forçado
SIRIUS HRI 190 W+	5x3.8 mm	51,0 mm	54.2 mm	3000 h	Qualquer	Arrefecimento forçado
SIRIUS HRI 230 W	5x3.8 mm	51,0 mm	54,5 mm	2500 h	Qualquer	Arrefecimento forçado
SIRIUS HRI 231 W		51,0 mm	50,0 mm	2000 h	Qualquer	
SIRIUS HRI 251 W		51,0 mm	61,0 mm	3000 h		
SIRIUS HRI 260 W PRO		51,0 mm	50,0 mm	6000 h		
SIRIUS HRI 280 W	5x3.8 mm	51,0 mm	54,5 mm	2000 h	Qualquer	Arrefecimento forçado
SIRIUS HRI 280 W RO		51,0 mm	54,5 mm	2000 h	Qualquer	
SIRIUS HRI 281 W		51,0 mm	50,0 mm	2000 h	Qualquer	
SIRIUS HRI 310 W PRO		58,0 mm	72,0 mm	6000 h		
SIRIUS HRI 311 W		51,0 mm	50,0 mm	1500 h		
SIRIUS HRI 330 W	8.0 mm	56,0 mm	63,0 mm	1500 h	Qualquer	Arrefecimento forçado
SIRIUS HRI 330 W X8		58,0 mm	66,0 mm	1500 h	Qualquer	
SIRIUS HRI 330 W XL		56,0 mm	63,0 mm	1500 h	Qualquer	
SIRIUS HRI 370W LL		58,0 mm	72,0 mm	6000 h	Qualquer	
SIRIUS HRI 371 W		58,0 mm	72,0 mm	1500 h	Qualquer	
SIRIUS HRI 371 W S		58,0 mm	72,0 mm	1500 h	Qualquer	
SIRIUS HRI 371 W +		58,0 mm	72,0 mm	3000 h		
HRI 371 W S +		58,0 mm	72,0 mm	3000 h		
SIRIUS HRI 380 W Pro		58,0 mm	72,0 mm	2500 h		
SIRIUS HRI 420 W		58,0 mm	72,0 mm	2500 h		
SIRIUS HRI 440 W	8.0 mm	58,0 mm	71,0 mm	1500 h	Qualquer	Arrefecimento forçado
SIRIUS HRI 440 W H		65,0 mm	60,0 mm	1500 h	Qualquer	
SIRIUS HRI 440 W S		11,8 mm	71,0 mm	1500 h	Qualquer	
SIRIUS HRI 440 W X		58,0 mm	71,0 mm	1500 h		
SIRIUS HRI 461 W		60,0 mm	67,0 mm	1500 h	Qualquer	
SIRIUS HRI 461 W S		60,0 mm	67,0 mm	1500 h	Qualquer	
SIRIUS HRI 470 W S		58,0 mm	71,0 mm	1500 h	Qualquer	
SIRIUS HRI 470 W RO		60,0 mm	67,0 mm	1500 h	Qualquer	
SIRIUS HRI 470 W XL		60,0 mm	67,0 mm	1500 h	Qualquer	
SIRIUS HRI 471 W SN		60,0 mm	67,0 mm	1500 h	Qualquer	
SIRIUS HRI 550 W		60,0 mm	67,0 mm	1500 h		

Ficha técnica da família de produto

Descrição do produto	Normas e Certificações	Environmental information Information according Art. 33 of EU Regulation (EC) 1907/2006 (REACH)		
	EEI – Etiqueta de Eficiência Energética	Date of Declaration	Primary Article Identifier	Declaration No. in SCIP database
SIRIUS HRI 100 W	B	07-04-2022	4052899321656 4052899329119	In work
SIRIUS HRI 132 W SC	A	07-04-2022	4052899011335 4052899028708 4052899197404	In work
SIRIUS HRI 140 W RO	A	07-04-2022	4052899224056 4052899258969	In work
SIRIUS HRI 190 W+	A	07-04-2022	4008321678201 4052899028739	In work
SIRIUS HRI 230 W	A	07-04-2022	4008321678225 4008321810311	In work
SIRIUS HRI 231 W	A	07-04-2022	4052899512634 4052899553521 4062172041430 4062172128681 4062172212311	In work
SIRIUS HRI 251 W		13-04-2022	4062172212458 4062172212434	In work
SIRIUS HRI 260 W PRO		07-04-2022	4062172118941 4062172118927	In work
SIRIUS HRI 280 W	A	07-04-2022	4008321734303 4008321810342 4052899110397	In work
SIRIUS HRI 280 W RO	A	07-04-2022	4052899082151	No declarable substances contained
SIRIUS HRI 281 W	A	07-04-2022	4052899553552 4062172041454 4062172128704	In work
SIRIUS HRI 310 W PRO		07-04-2022	4062172085304 4062172169424 4062172169455	In work
SIRIUS HRI 311 W		07-04-2022	4062172169363	In work
SIRIUS HRI 330 W		07-04-2022	4008321754448 4008321810373	In work
SIRIUS HRI 330 W X8	A	07-04-2022	4052899140295 4052899140325 4052899224346	In work
SIRIUS HRI 330 W XL		07-04-2022	4008321848765 4052899195431	In work
SIRIUS HRI 370W LL		07-04-2022	4052899569188 4062172056816	In work
SIRIUS HRI 371 W		07-04-2022	4062172057004 4062172056984 4052899558649	In work
SIRIUS HRI 371 W S		07-04-2022	4062172056953 4062172056939 4052899558618	In work
SIRIUS HRI 371 W +		07-04-2022	4062172110341 4062172110327	In work

Ficha técnica da família de produto

Descrição do produto	Normas e Certificações	Environmental information Information according Art. 33 of EU Regulation (EC) 1907/2006 (REACH)		
	EEI – Etiqueta de Eficiência Energética	Date of Declaration	Primary Article Identifier	Declaration No. in SCIP database
HRI 371 W S +		07-04-2022	4062172110396 4062172110372	In work
SIRIUS HRI 380 W Pro		11-04-2022	4062172168625 4062172168601	In work
SIRIUS HRI 420 W		07-04-2022	4062172192750 4062172192736	In work
SIRIUS HRI 440 W	A	07-04-2022	4052899222212 4052899259096 4052899553644 4052899570566 4052899587892	In work
SIRIUS HRI 440 W H		07-04-2022	4052899509528 4052899576735	In work
SIRIUS HRI 440 W S	A	07-04-2022	4052899276543 4052899329140	In work
SIRIUS HRI 440 W X		07-04-2022	4062172017442	No declarable substances contained
SIRIUS HRI 461 W		07-04-2022	4052899532274 4052899553613	No declarable substances contained
SIRIUS HRI 461 W S		07-04-2022	4052899532298 4052899553583	No declarable substances contained
SIRIUS HRI 470 W S		07-04-2022	4052899580985 4062172169301	In work
SIRIUS HRI 470 W RO	A	07-04-2022	4052899476998 4052899477018	In work
SIRIUS HRI 470 W XL		07-04-2022	4052899581166 4062172017473 4062172168281	In work
SIRIUS HRI 471 W SN		07-04-2022	4052899581005 4062172040358	In work
SIRIUS HRI 550 W		07-04-2022	4062172008761 4062172078122	In work

Descrição do produto	Candidate List Substance 1
SIRIUS HRI 100 W	
SIRIUS HRI 132 W SC	No declarable substances contained
SIRIUS HRI 140 W RO	No declarable substances contained
SIRIUS HRI 190 W+	No declarable substances contained
SIRIUS HRI 230 W	No declarable substances contained
SIRIUS HRI 231 W	No declarable substances contained
SIRIUS HRI 251 W	

Ficha técnica da família de produto

Descrição do produto	Candidate List Substance 1
SIRIUS HRI 260 W PRO	
SIRIUS HRI 280 W	No declarable substances contained
SIRIUS HRI 280 W RO	No declarable substances contained
SIRIUS HRI 281 W	No declarable substances contained
SIRIUS HRI 310 W PRO	
SIRIUS HRI 311 W	
SIRIUS HRI 330 W	No declarable substances contained
SIRIUS HRI 330 W X8	No declarable substances contained
SIRIUS HRI 330 W XL	No declarable substances contained
SIRIUS HRI 370W LL	No declarable substances contained
SIRIUS HRI 371 W	No declarable substances contained
SIRIUS HRI 371 W S	No declarable substances contained
SIRIUS HRI 371 W +	
HRI 371 W S +	
SIRIUS HRI 380 W Pro	
SIRIUS HRI 420 W	
SIRIUS HRI 440 W	No declarable substances contained
SIRIUS HRI 440 W H	No declarable substances contained
SIRIUS HRI 440 W S	No declarable substances contained
SIRIUS HRI 440 W X	No declarable substances contained
SIRIUS HRI 461 W	No declarable substances contained
SIRIUS HRI 461 W S	No declarable substances contained
SIRIUS HRI 470 W S	
SIRIUS HRI 470 W RO	No declarable substances contained
SIRIUS HRI 470 W XL	No declarable substances contained
SIRIUS HRI 471 W SN	No declarable substances contained
SIRIUS HRI 550 W	

Ficha técnica da família de produto

Instruções de segurança

Devido à sua luminância alta, à radiação UV e à pressão interna alta durante a operação, as lâmpadas SIRIUS HRI somente podem ser operadas em estojos de lâmpadas embutidos, especialmente construídos para esse fim. Filtros adequados precisam assegurar que a radiação UV seja reduzida até um nível aceitável. O mercúrio será liberado se a lâmpada quebrar. Precauções de segurança especial precisam ser tomadas. Informações sobre segurança e manuseio estão disponíveis mediante solicitação ou podem ser encontradas no folheto incluído com a lâmpada ou nas instruções de operação.

Informações sobre aplicações

Para obter mais informações sobre aplicações e gráficos acesse a ficha técnica do produto.

Retratção

Sujeito a alteração sem prévio aviso. Sempre utilize a versão mais recente.